

MR-compatible camera “12M-i newSensor” with integrated LED light

User manual

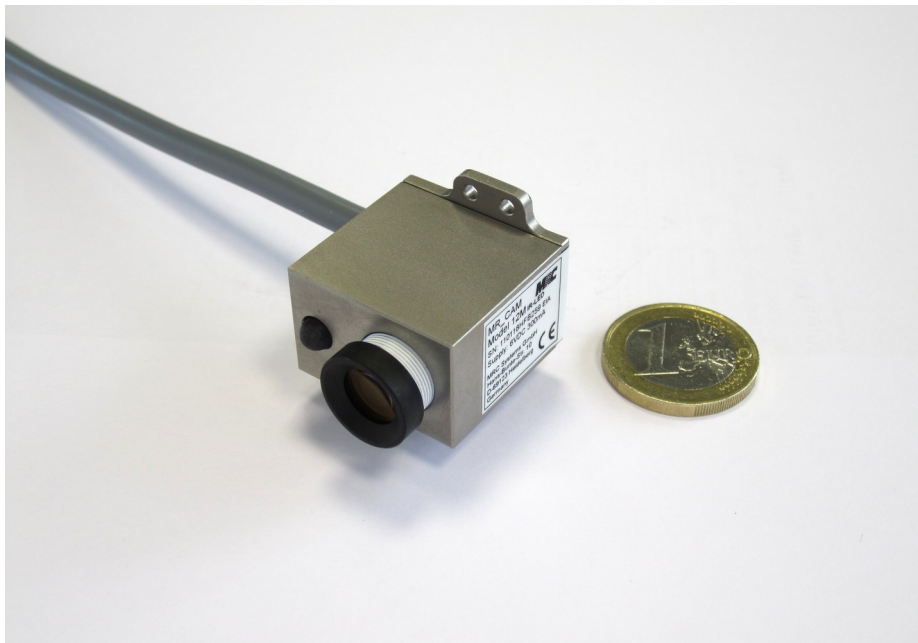

1. Intended use

Our MR compatible cameras are designed to view and record video images of subjects in an MR scanner. They can also be used for the monitoring of objects and instruments. The cameras can be used inside the bore of the scanner. They can be equipped with different exchangeable lenses. The correct orientation of the cables, the correct installation of the filter box, and the correct grounding should be checked before the application. Respective descriptions can be found in this user manual.

The cameras are tested in MR scanners with static fields of up to 7T, higher fields may be possible, too.

In the 12M-i models, an LED for different illumination purposes like face monitoring or eye-tracking is integrated. It is based on a single light-emitting-diode (LED) which is embedded in the titanium housing and emits diffuse light.

The cameras are not equipped with an automatic alert in case of an interruption of the video stream. That is why they are not intended to identify critical states or situations.

2. System components

- Camera
- LED
- Filter box *newSensor* (with optical isolation of video signal and LED control).
- Camera connection cable (length: 10 m, 2 m at the camera + 8 m elongation cable)
- Power supply (length: 1.8 m)
- BNC cable (length: 2 m)
- BNC/Cinch adapter
- Earth ground cable for provisional installation

Note: The filter box *newSensor* is not compatible with the former model!

There are different types of LEDs that can be used with the camera. It is possible to provide both, visible or infrared light.

3. Video camera, lens and LED light

Figure 1 shows the camera housing with the LED and a connected lens.

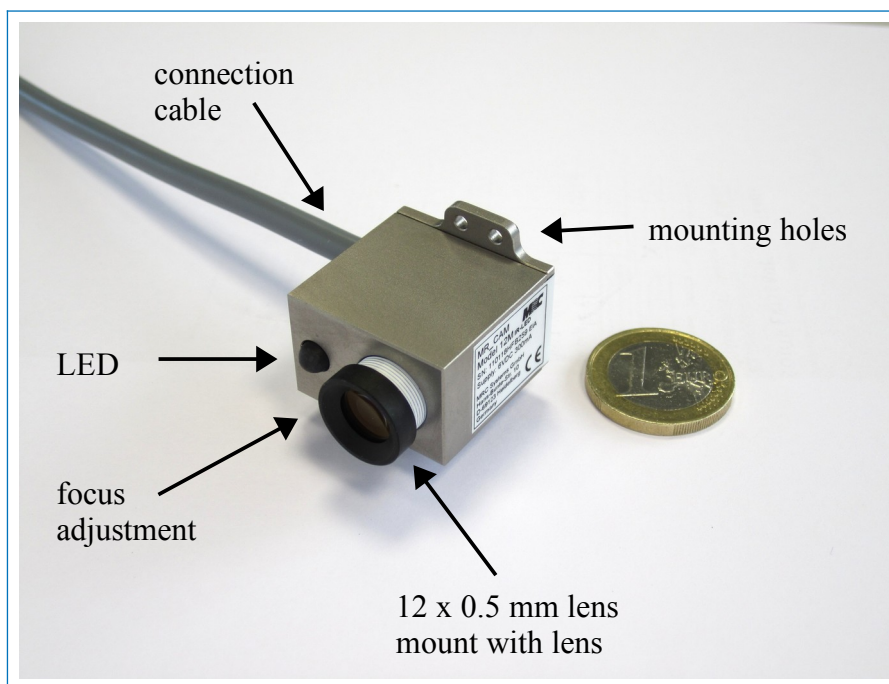

*Figure 1:
Video camera with LED
and lens*

The lens is connected to the standard **M12 mount** in the housing.

- The **focus adjustment** is done by screwing the lens in and out. Care should be taken not to screw out the lens too far, as the lens may fall out of the thread.

The LED light is embedded in the camera housing. The distance to the lens is chosen in order to avoid undesired shadowing effects.

The device is connected to the filter box via a connection cable which must be plugged into the “MR CAM Signal IN” connector.

It can be mounted directly to any suitable object via the 2 mm holes in the camera backplate.

4. Mounting options

The device can be mounted directly to any suitable object via the two 2 mm holes in the backplate.

Standard mounting options are:

1. direct mounting of the camera using the mounting holes
2. use of an articulated arm (optional accessory) for mounting the camera e.g. to the head coil
3. use of a ball joint mount (optional accessory) e.g. for use inside the MR bore
4. use of a mirror mount (optional accessory) to observe the eyes or the face inside a MR head coil
5. use of a tripod adapter (optional accessory) for mounting the camera on a tripod

You can find photos of the optional accessories in section 11 of this manual.

5. Connection of camera/LED to filter box

The powering of the camera and the LED is arranged via the filter box. The camera/LED is connected to the filter box with the shielded camera connection cable which includes the power and the signal lines.

The filter box prevents the transmission of disturbing signals into the MR cabinet. It avoids interferences in the video signals and the MRI imaging.

The filter box includes a low pass filter that suppresses frequencies higher than 1 MHz with over 100 dB. This filter prevents damage and interferences caused by the high frequency signals of the MR scanner. In addition, the filter box includes an optical isolation of the video signals. In that way a full separation of the MRI equipment from the external power network is guaranteed.

Note: The filter box is only suitable for the camera 12M-i with integrated LED. Connecting the standard 12M or CS camera to the filter box will destroy the integrated electronics!



Figure 2: Filter box (front side)

6. Filter box installation

The filter box should be mounted at the filter panel board of the MR room. It has to be placed outside of the MR room, The cable between camera and filter box has to be routed through a hole into the MR room.

For a permanent installation, the filter box should be screwed onto the panel board by means of the feed through **camera connector** (see figure 2). Figure 3 illustrates the recommended configuration:

- A 12 mm through hole in the panel board is required.
- The **camera connector** is guided through this hole.
- The camera connector provides the ground connection to the shielding of the MR cabinet.

For temporary use, the camera cable can be brought into the MR cabinet by other means, e.g. through a service entry hole (“waveguide”). In this case, an additional grounding cable should be used to connect the camera connector to the shield panel grounding. The camera connector must completely protrude into the MR cabinet and the video cable must not jut out.

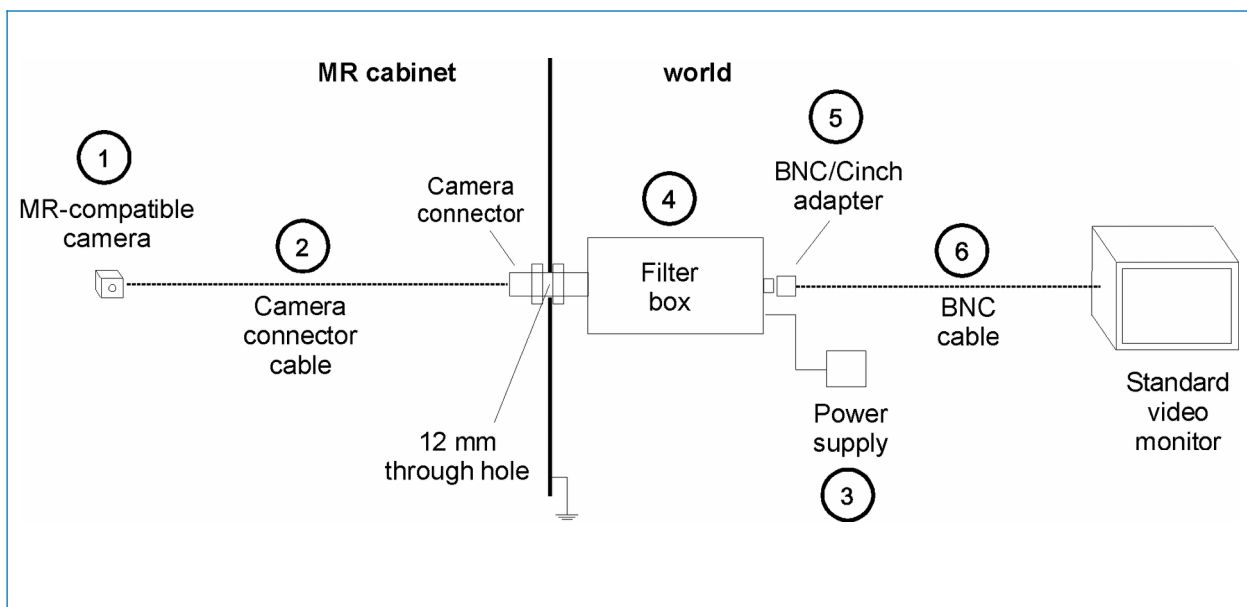

Figure 3: Device and cable configuration

7. Connection of power supply, light intensity adjustment

The power for the camera is transmitted via the video cable. Therefore, the power supply is connected to the filter box (see figure 4). Next to the video connector is a green “active” signal which shines when the device is powered and the LED on the front side of the camera is turned on. By pushing the button of the “active” signal the LED can be switched off. The intensity of the LED light can be adjusted by means of a potentiometer at the filter box.

7.1. Eye safety

The infrared LED in the camera is eye-safe. The peak wavelength is 850 or 950 nm. We recommend to keep a distance between the light source and the subject's eye of 50 mm or more. With the white-light LED you should avoid to shine directly into the eye. Please be aware that the lid-closing reflex of babies can be unincisive.



Figure 4:
Filter box (rear side)

8. Connection of TV set, VCR, frame grabber, or video card

A BNC/Cinch adapter and a standard BNC cable are used to transfer the video output signal to a TV set, VCR, frame grabber, or video card. The BNC cable is plugged to the video connector at the filter box (see figure 4).

The video signal can be directly viewed with a TV set or recorded with a VCR. To view and store the images with a PC, the BNC/Cinch cable must be connected via an analog frame grabber to the PC. Any software for analog video viewing should be appropriate to process the signals.

9. Maintenance and cleaning

Light-emitting diodes (LEDs) are subject to an ageing process which is accelerated if the LEDs are driven at highest powers. In order to increase the lifetime of the product we recommend not to drive the light source with highest intensity and to disconnect it from mains whenever it is not in use.

The device should be applied in dry environments. It is not sealed against splash water and rinsing liquids.

The housing and the lens can be cleaned with a dry cloth. If this is not sufficient, the cloth can be moistened with clear water or alcohol.

10. Technical data

Video camera

Sensor Type: Color CMOS Sensor 1/4 inch, active sensor size: 4.1 mm x 3.1 mm
Output: NTSC video signal with 60 Hz half frame rate
or PAL video signal with 50 Hz half frame rate

Spectral sensitivity

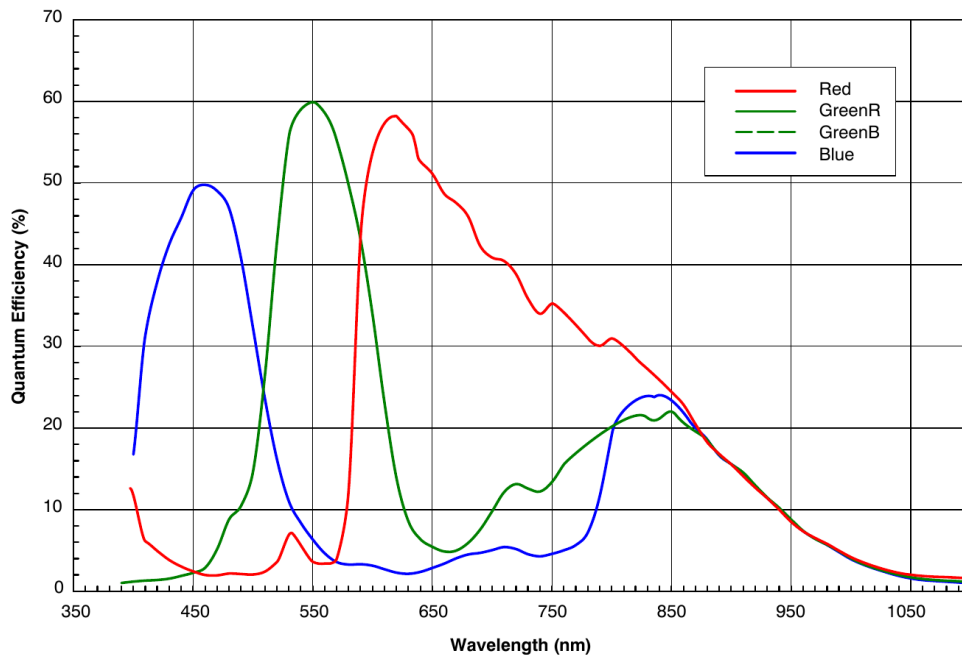

Housing dimensions

Dimensions: 27 mm x 18 mm; height \approx 27 mm + lens (without mounting bracket)
 Connector for lens: 12 x 0.5 mm mount
 Mounting holes: two pairs of holes, 2 mm \varnothing , distance 23 mm
 Weight: 45 g (without cable)

LED

Spectrum: white or infrared (850 or 950 nm), diffused
 Current: 10-100 mA

Lenses

Type: fixed focal length with fixed aperture, exchangeable
 Mount: 12 x 0.5 mm
 Focal length: a big number of different focal lengths are available
 Standard delivery: focal lengths: 4.3 mm, 6 mm, 8 mm (other lenses on request)
 Aperture: e.g. 2.4
 Sensor format: 1/4 inch, active sensor size: 4.1 mm x 3.1 mm
 Minimal object distance: 50 mm (typical, depending on the chosen lens)

Electronics

Power supply: 300 mA, 5.9-6.3 V DC
 Output impedance: 75 Ω
 Type: Friwo FW8001M/06, 5.9 V (medical power supply)

Filter box

Dimensions: 80 mm x 120 mm x 80 mm
 Weight: approx. 700 g

11. Camera holders (optional accessories)

We offer different camera holders for the MR compatible camera. Examples are shown in the photos below. More information can be found in the specific product descriptions. We can also produce customised solutions.

On request, we can offer additional equipment like displays or video cards.

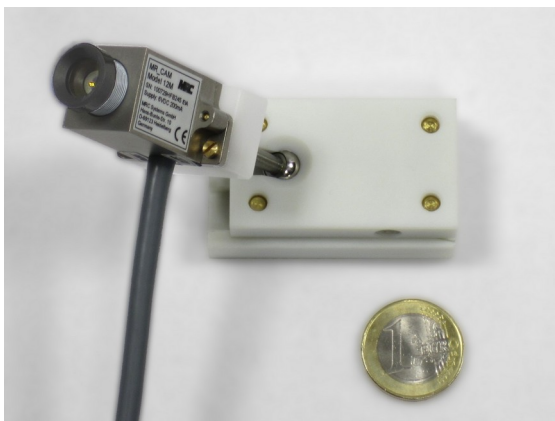

Camera holder with ball joint for easy alignment



Flexible camera holder based on articulated arm

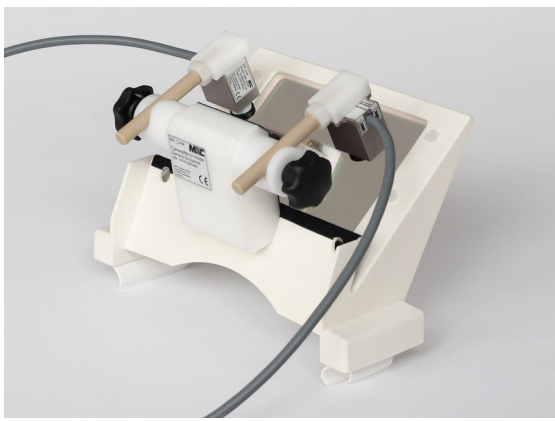

Camera holder with mirror for MR head coil

*Figure 5: Selection of MR compatible camera holders
(Some cameras shown in the photos are the standard 12M cameras without integrated LED.)*

12. Labelling

A label on the camera housing includes the information about the integrated LED (white or infrared) and the embedded video sensor (PAL[50Hz], NTSC[60Hz]). The following copies are enlarged:

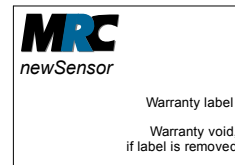
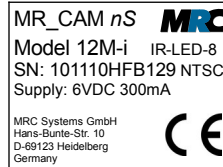
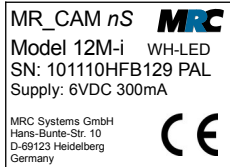

In addition, there is a label on the filter box:

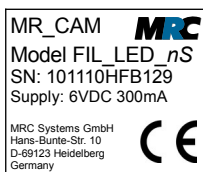

13. Contact

MRC Systems GmbH
Hans-Bunte-Strasse 10
D-69123 Heidelberg
Germany

phone: +49-6221-13803-00
fax: +49-6221-13803-01
mail: info@mrc-systems.de